

Subject: Sailplane Rigging – Procedures, Inspections and Training
Ref. Publications:

- Air Accident Investigation Unit of Belgium Final Report AAIU-2010-27 dated 07 January 2011.
- EASA [SIB 2011-11](#) dated 25 May 2011.
- Luftfahrt-Bundesamt (German Civil Aviation Authority), Lufttüchtigkeitsanweisung (LTA – Airworthiness Directive) 1993-001/3 and LTA 1994-001/2, both dated 09 April 1998.
- EASA [SIB 2012-04](#) dated 15 March 2012.
- Bundesstelle für Flugunfalluntersuchung - [Interim Report BFU18-1190-3X](#) and Safety Recommendation GERF-2018-08.
- Air Accidents Investigation Branch of the United Kingdom Bulletin 3/2018.
- EASA [AD 2018-0081](#) dated 11 April 2018.
- Safety Briefing of the British Gliding Association “Is Your Glider Fit for Flight?”

Applicability:

All sailplanes and powered sailplanes, subject to rigging.

Description:

Statistical data and some occurrence reports indicate a number of incidents, which were caused by improper execution of rigging procedures and its subsequent inspection. The nature of these incidents can be grouped as follows:

- Main wing not correctly rigged and connected.
- Horizontal stabilizer not correctly connected.
- Controls not, or not correctly, connected.
- Control connections not, or not correctly, secured.

Reasons for these incidents can be grouped as follows:

- Rigging procedure was interrupted; the person executing the rigging was distracted or interrupted, and consequently omitted important steps.
- The rigging procedure was not correctly followed.
- The rigging procedure was not well known by the person executing the rigging.
- The mechanical principles of the connection and/or its securing were not understood by the person executing the rigging.
- Connections and/or securing were not, or not correctly, inspected.
- No positive control check was performed.

This is information only. Recommendations are not mandatory.



An inadequately connected wing or horizontal stabilizer could lead to a separation from the fuselage, potentially resulting in loss of the sailplane. Inadequate or not connected controls could lead to loss of control of the sailplane.

At this time, the safety concern described in this SIB is not considered to be an unsafe condition that would warrant Airworthiness Directive (AD) action under Regulation (EU) [748/2012](#), Part 21.A.3B.

Recommendation(s):

In order to mitigate any safety risk related to the improper execution of rigging procedures and its subsequent inspection, EASA recommends taking the following proactive measures:

Familiarisation with Specific Sailplane Type

The necessary familiarisation with a new type of sailplane should not be limited to 'how to fly it', but should also include the rigging of the sailplane. Even if the flight manual offers detailed instructions how to perform the rigging, the familiarisation should be provided by a person familiar with the type of sailplane. This applies in particular to older (vintage) types of sailplanes, where the rigging procedures are not described in detail in the flight manual.

It is recommended that familiarisation with the rigging procedure are provided by a person familiar with the type. This might include repetitive training of some rigging actions.

Interruption and Distraction

Rigging errors, other errors, and omissions in preparing a glider for flight, are frequently caused by interruption, distraction, forgetfulness, and making unwarranted assumptions. EASA stresses the importance of rigging, and performing daily inspections and pre-flight checks, without interruption or distraction.

- Bystanders shall not interrupt people, who are rigging, carrying out daily inspections, or conducting their pre-flight checks.
- Persons, who are engaged in these activities and disturbed by someone, should send the disturbing person away.
- Gliding sites should develop a culture that ensures global awareness of the importance of conscientious rigging, daily inspections, and pre-flight checks.
- It is beneficial to perform double inspection of control connections, before inspection or assembly holes are closed.

If rigging is conducted by a team, it should be ensured that one single person is responsible for directing operations of the rigging, and that the loose article and positive control checks are undertaken.

Positive Control Checks

It is strongly recommended to perform positive control checks as part of the daily inspection, regardless whether the sailplane was rigged or not, or it has automatic control connections. The control check should involve at least two individuals; one to hold the control surface stationary, while the other attempts to move the flight controls in both directions. In addition, it

This is information only. Recommendations are not mandatory.



should be checked, if the movement direction of the control surface corresponds with the control input and the full deflection angle is as expected. This procedure should be applied for each control surface including air brakes and flaps. The procedure should also include the wing and tailplane fittings, control connections, locking pins, total energy probes and rigging hatches. It is recommended that the checking is performed by a qualified person, who was not involved in the rigging, or at least had a break between rigging and checking.

Principle of engage and secure

To engage means e.g. that a bolt is inserted into a bushing. In this condition, the connection is able to transmit forces, but the bolt can move out of the bushing again, therefore the connection is not secure. All connections need to be engaged and secured.

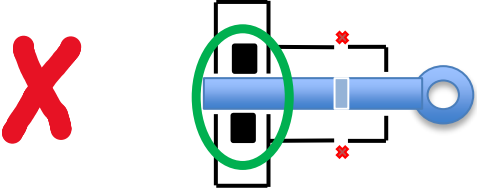
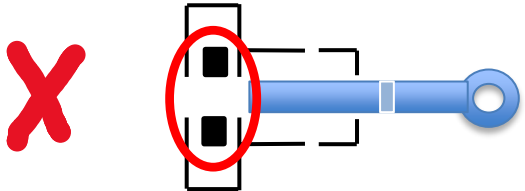
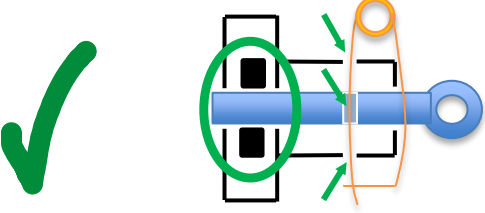
	
Engaged but <u>not</u> secured.	The bolt moved away from its engaged position, and the control is unconnected.
	The Fokker-needle needs to be pushed through both holes of the cage and the hole of the bolt.
Engaged and secured.	

Securing of Castellated Nuts







Some connections need to be secured against rotation. In most of the cases, this is achieved by the use of a castellated nut and a Fokker-needle. The pin of the needle has to be pushed through two castells and a hole inside the screw.

Manual Control Connections and Attachment of Horizontal Stabilizers

Sailplanes with manual control connections are noticeable in accident statistics, due to forgotten control connections. Pilots sometimes forget to connect the manual controls subsequent to the attachment of the wings. The related accidents usually result in fatal, or at least major, injuries. Similar scenarios may happen with horizontal stabilizers that have to be secured by a bolt, especially in cases where the application requires the use of a tool. Pilots attach the horizontal stabilizer and walk away to collect the bolt and/or the respective tool. However, they may never return to secure the horizontal stabilizer. Interruption and distraction are very often contributing to these events.

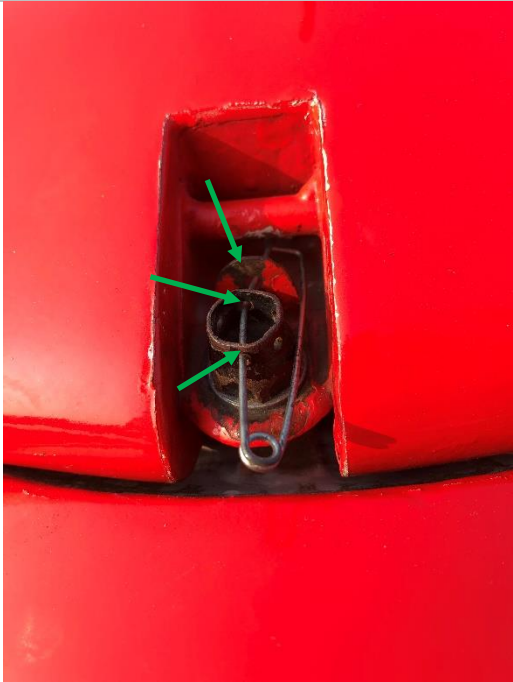
This is information only. Recommendations are not mandatory.



		<p>The bolt needs to be engaged and secured against rotation.</p>
	<p>Horizontal stabilizer engaged in its aft fitting but forward fitting not engaged.</p>	
	<p>Horizontal stabilizer properly engaged.</p>	

This is information only. Recommendations are not mandatory.



Note: All cases of unconnected controls and unconnected horizontal stabilizers can be detected by performing a positive control check. Non-interruption during the rigging helps to prevent forgetting the connections in the first place. The checking of proper securing can be done by a visual inspection only.

Securing of Manual Control Connections

The example below shows an aileron connection, which is typical for old sailplanes with manual control connections. In this case, the connection was engaged during rigging, but not correctly secured. After three flights of short duration, the bolt moved away from its engaged position. The pilot lost control and crashed fatally.



The connection was not secured. The Fokker-needle was put through one hole of the cage only, but not through the bolt and the lower hole of the cage, as well. By this, the bolt could move freely and the control connection could become unconnected.

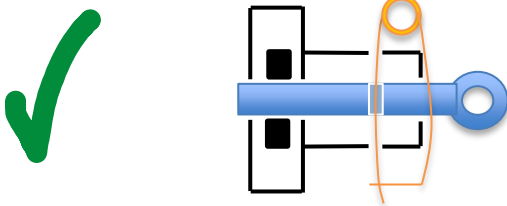

The bolt is secured by pushing the Fokker-needle through all three holes.

This is information only. Recommendations are not mandatory.



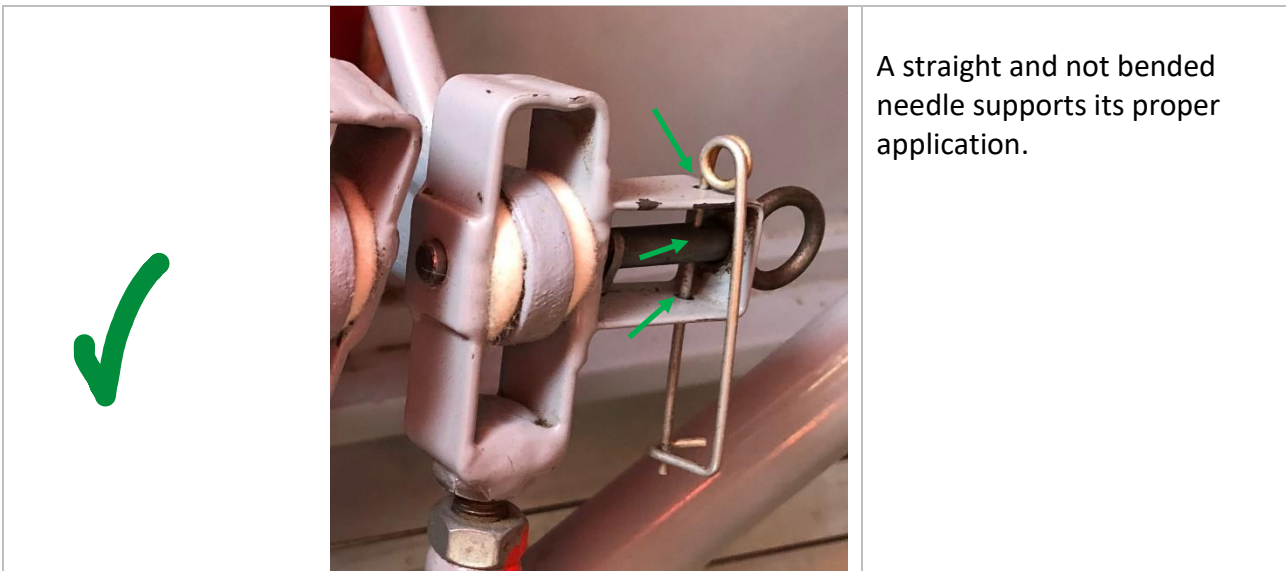

Note: Connections, which are not properly secured, cannot be detected by positive control checks. The proper securing can be verified only by a manual inspection through turning, pulling, or shaking of the bolt and further visual inspection.

Typical Automatic Control Connections

The typical automatic connection for the air brakes, ailerons, and flaps are located in the wing-to-fuselage joint. Those consist of a drive funnel inside the fuselage and a bell crank at the root rib of the wing. During assembly of the wing, it has to be ensured that the bell crank moves inside the drive funnel. Controls and control surfaces need to be in the positions as indicated by the flight manual, to ensure that the bell crank and drive funnels have the correct position to enable their proper connection.

Similar designs can be found for the control connection of the elevator. Pictures below show an example of a mis-rigged vertical stabilizer, which led to a fatal accident. The mis-rigging had its root cause in an unauthorized and apparently unrecorded modification, to make rigging easier.



Disconnected elevator control



Disconnected elevator control

This is information only. Recommendations are not mandatory.

Note: Those examples of rigging errors can usually be detected by a proper positive control check as indicated above.

L'Hotellier Ball and Swivel Joint Quick Connectors

A number of rigging accidents have involved the L'Hotellier quick connectors found in many popular sailplanes. While in many cases the connections had simply been forgotten, in others the pilot had made the connections incorrectly.

L'Hotellier connections rely upon proper engagement of a ball and socket, which are secured by a spring-loaded tab that must be pressed out of the way to make the connection. With the tab in position, a witness hole is exposed, allowing a locking pin/clip to be fitted to secure the connection. The controls can become disconnected in flight, if the pin is not fitted.

Unfortunately, the tab adopts a similar position when the ball and socket are completely disconnected and, although the ball is then locked out of the socket, it may in some cases engage sufficiently for the controls to seem connected. Being able to insert the locking pin does not guarantee that the connection has been properly made.

It is crucial to check that the ball and socket are correctly engaged. This can be difficult, if access is tight or illumination poor; a torch and mirror, or telephone camera, can help.

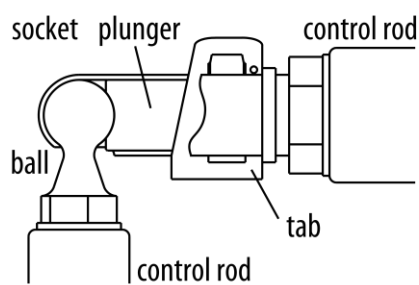

(a) Correct: cut-away shows how tab holds plunger in place

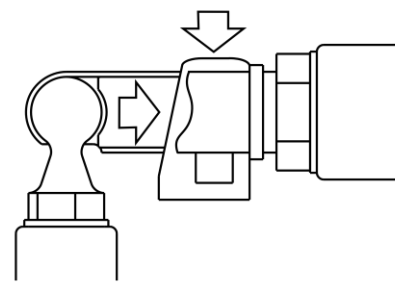

(b) Open: with tab depressed, plunger allows ball to be inserted or removed

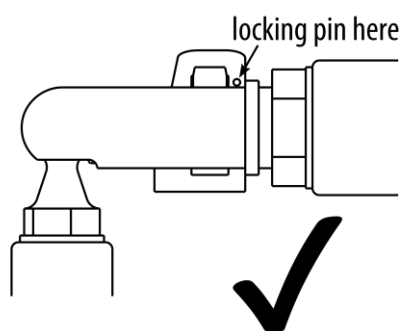

(c) Correct: ball engaged, locking pin may be inserted

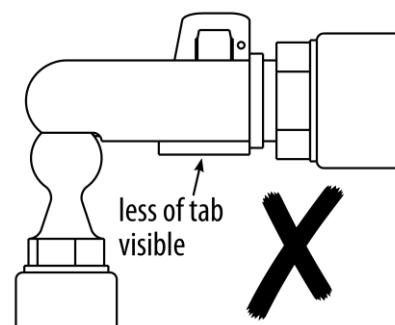



(d) Incorrect: ball not engaged, but locking pin may still be inserted

There are several common modifications to dispense with the locking pin.

This is information only. Recommendations are not mandatory.

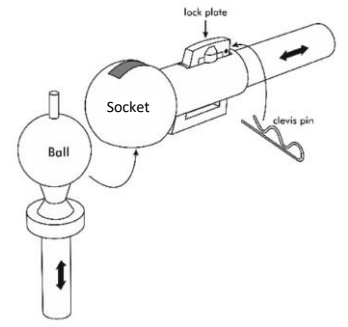

	<p>The Wedekind locking sleeve slides outside the l'Hotellier fitting to secure the tab, but doesn't necessarily prevent partial engagement.</p>
	<p>The Uerlings sleeve and similar threaded sleeve used on LS-sailplanes rotate or unscrew over the coupling and cannot be moved into position, if the ball and socket are only partially engaged.</p>
	<p>Newer l'Hotellier connectors come with a pin on the top of the ball that becomes visible outside the socket, once the ball and socket are properly engaged. The pin allows also for a tactile inspection. The connection still needs to be secured.</p>

Remark: The maintenance instructions of l'Hotellier, in particular about ball wear need to be respected.

Note: To check the proper engagement of l'Hotellier connectors, a positive control check is strongly recommended.

Expanding Main Pins of Main Wing Connection:

The wing rigging pins for most gliders are smooth cylinders, but those for e.g. the Foka, Cobra, Bocian, Jaskółka, Schempp-Hirth SHK and Austria, consist of expanding pins/cones, which must be fitted exactly in accordance with the instructions of the flight manual. If the pin/cone is not correctly located, the wings can fold up and detach from the fuselage. Unless inspection holes have been cut for the purpose, it can be very difficult in some gliders to see whether the fitting has been assembled correctly.

This is information only. Recommendations are not mandatory.



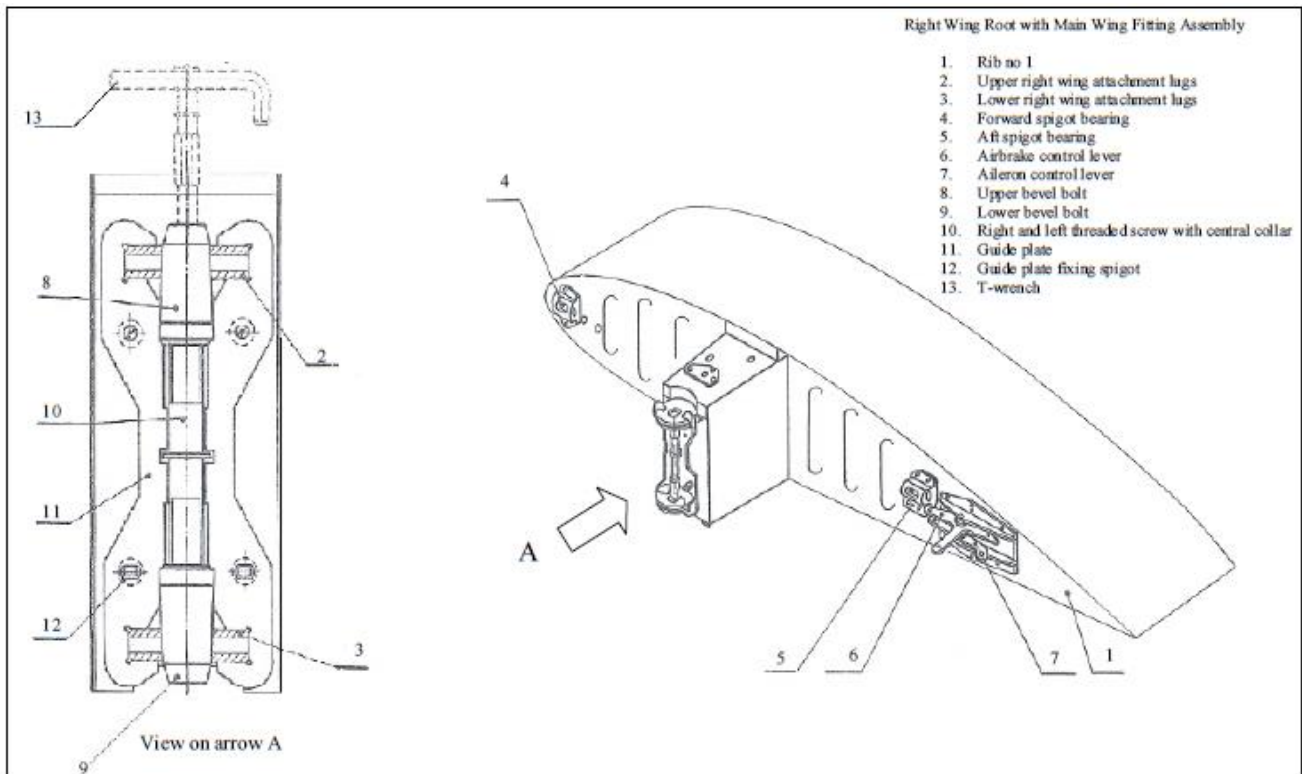

Example of an expanding main pin wing connection.

Note: In case of sailplanes with expanding main pin wing connections, practice rigging should be carried out under the supervision of someone who is familiar with the sailplane type.

Safety Promotion:

It is recommended that gliding communities develop training material and sessions on rigging procedures and typical mistakes observed. The material and training should provide a basic understanding of the design of standard connections and their proper operation. Local gliding clubs should provide rigging training tailored to the respective fleet in operation.

Contact(s):

For further information contact the EASA Programming and Continued Airworthiness Information Section, Certification Directorate. E-mail: ADs@easa.europa.eu.

This is information only. Recommendations are not mandatory.

